

2024 Product Catalog



DRYERS



SIGNAGE



VACUUMS



PALM DRYERS



LED LIGHTING

premier

Your Manufacturing Partner



Dryers



- Arch Dryers 4
- Exterior Wall Mount Dryers..... 6
- Interior Wall Mount Dryers..... 7
- Tunnel Dryers 8
- Producers..... 9
- Oscillating Options 10
- Evolution Series..... 11
- Air Blanket for Evolution Series 14
- UL® Listed VFD & Starter Panels 15

Signage



- Arches & Overheads 16
- Menu & Menu Boards 21
- Pay Station Canopies 22
- Pedestals & Wall Mounts 23
- Roto-Molded Signs 23
- Tunnel/Wall Signs..... 24
- Channel Letters 24
- Clearance & Clearance Structures 25
- Custom Shaped Wall Pedestals & Wall 26
- Printed ACM 27
- ACM In-Bay Signage 27

Who We Are

We are a family owned, industry-leading company, offering complete metal fabrication, finishing services and products. Premier Companies has its own product line that supplies the car wash, and many other industries with Dryers, Vacuums, Signage, LED Lighting and Canopy Stations. All of our products are proudly designed and manufactured in Central Wisconsin.

PROUDLY MADE IN



What We Do

The selection of products manufactured by Premier Companies are not only of the highest quality, but are also available in a variety of options to ensure you find exactly what you're looking for. With top-of-the-line materials, cutting-edge production technologies and a highly qualified team, we guarantee complete satisfaction.

WISCONSIN, USA 



Vacuums

Silver Bullet	28
Stainless Steel Canopy Vacs	29
Stainless Steel Vacs.....	30



Palm Dryers

Palm Dryers.....	32
------------------	----



LED Lighting

Color Changing	
LED Tube Lighting	34

Premier manufactures custom drying equipment for many industries all over the world. Many hours and years of experience studying air flow and air distribution have made our dryers number one on the market.

At Premier, our customers are our partners. We provide our customers with individualized solutions to maximize functionality for the perfect dryer system set up. Not only does Premier provide great products and service, we also lead in price, custom design, private labeling and dryer performance. Our positive and knowledgeable staff are ready and available to make your venture a profitable and enjoyable experience.

Floor Mounted Arch Dryers

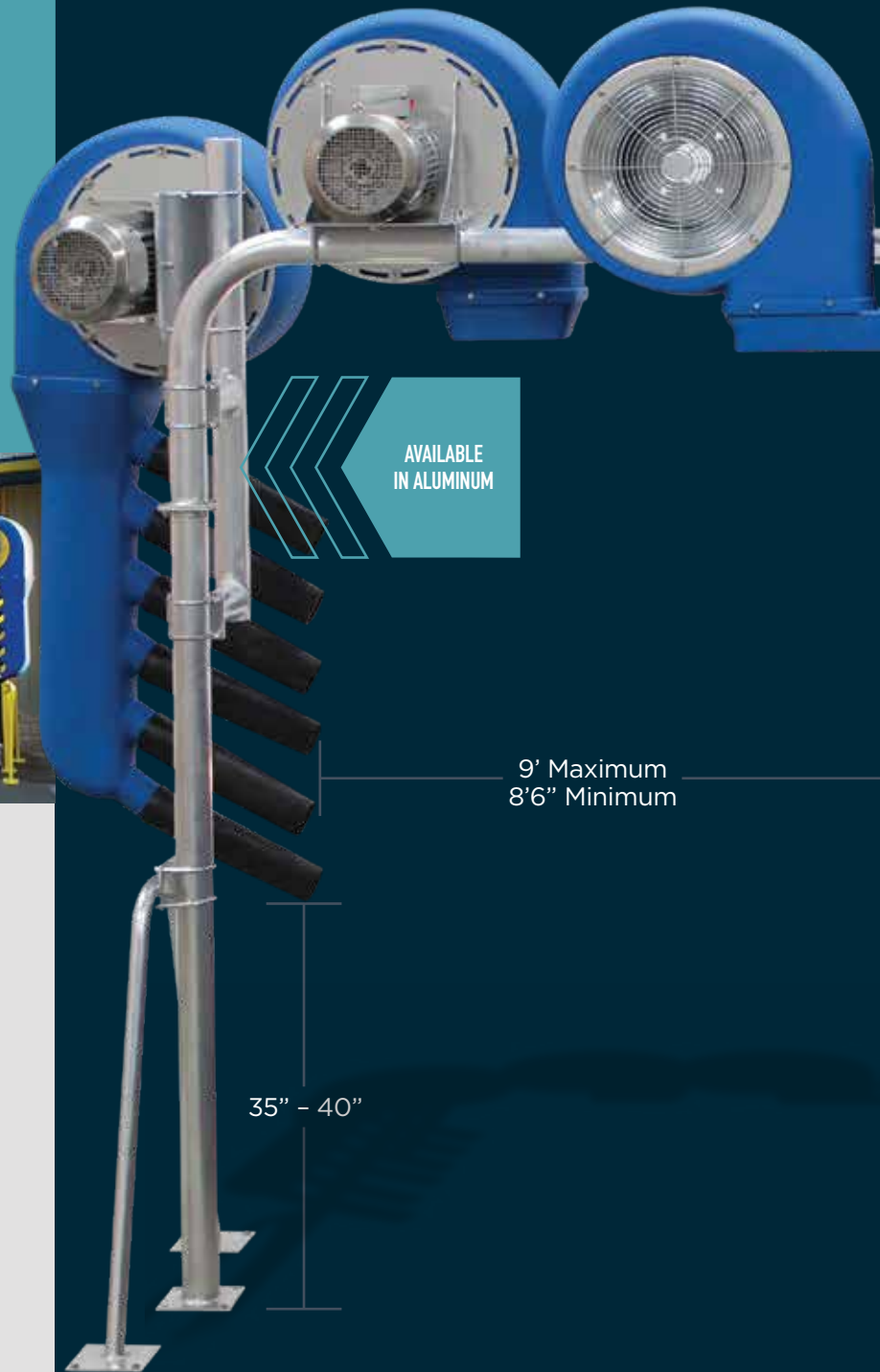

AVAILABLE IN ALUMINUM

9' Maximum
8'6" Minimum

35" - 40"



- Arches available in aluminum or stainless steel:



Aluminum Stainless Steel

- Standard dryer clearance is 90", but is fully customizable to any specs desired
- HDPE producer housing colors available:



Blue Black Granite Gray Red Green Yellow



MOTORS AVAILABLE
IN 5HP, 7.5HP, 10HP
OR 15HP

MANY NOZZLE
OPTIONS ARE
AVAILABLE
page 9

AVAILABLE
IN STAINLESS
STEEL

Common Arch Configurations

Additional and customizable configurations are available. Please contact us.

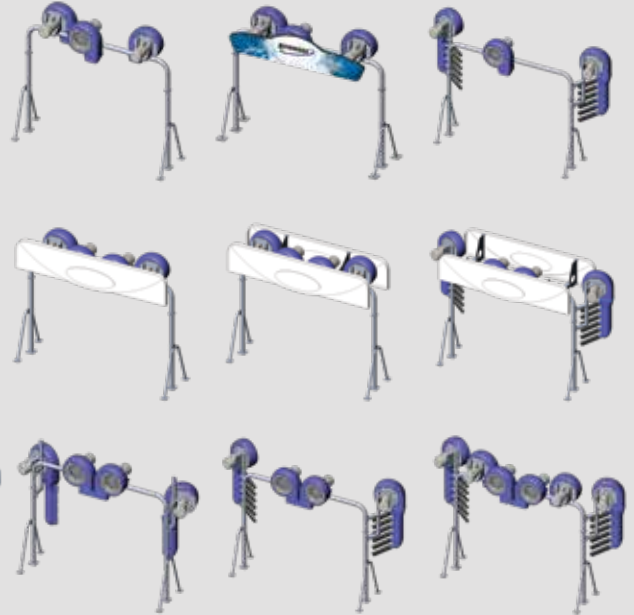

Arch Dimensions

Standard dryer clearance is 90", but is fully customizable to any specs desired.

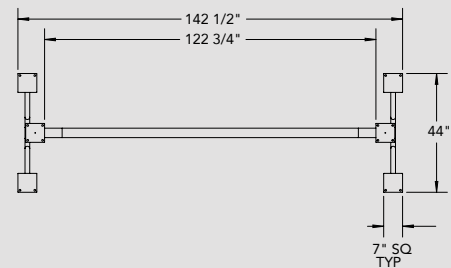
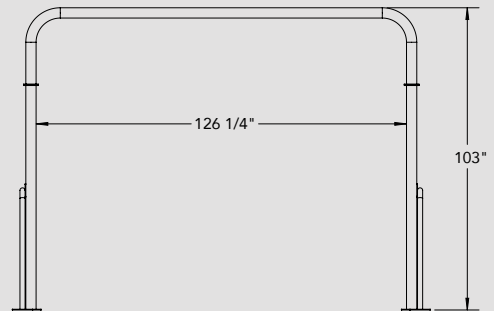



SEVERAL
PRODUCER
HOUSING COLORS
ARE AVAILABLE

Exterior Wall Mount Dryers

- Aluminum and stainless steel available



Aluminum Stainless Steel

- HDPE producer housing colors available:



Blue Black Granite Gray Red Green Yellow

- Standard powder coat colors are:



Blue Black Gray Red Green Yellow White

- Custom powder coat colors available by request

Common Exterior Dryer Configurations

Additional and customizable configurations are available. Please contact us.

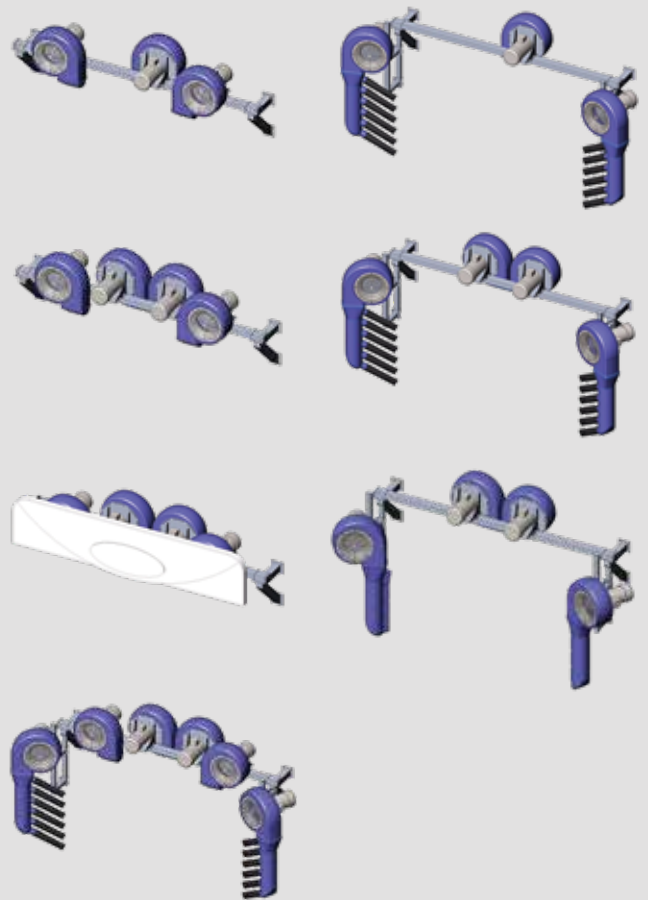



VARIOUS
POWDER COAT
COLORS ARE
AVAILABLE

Interior Wall Mount Dryers



Common Interior Dryer Configurations

Additional and customizable configurations are available. Please contact us.

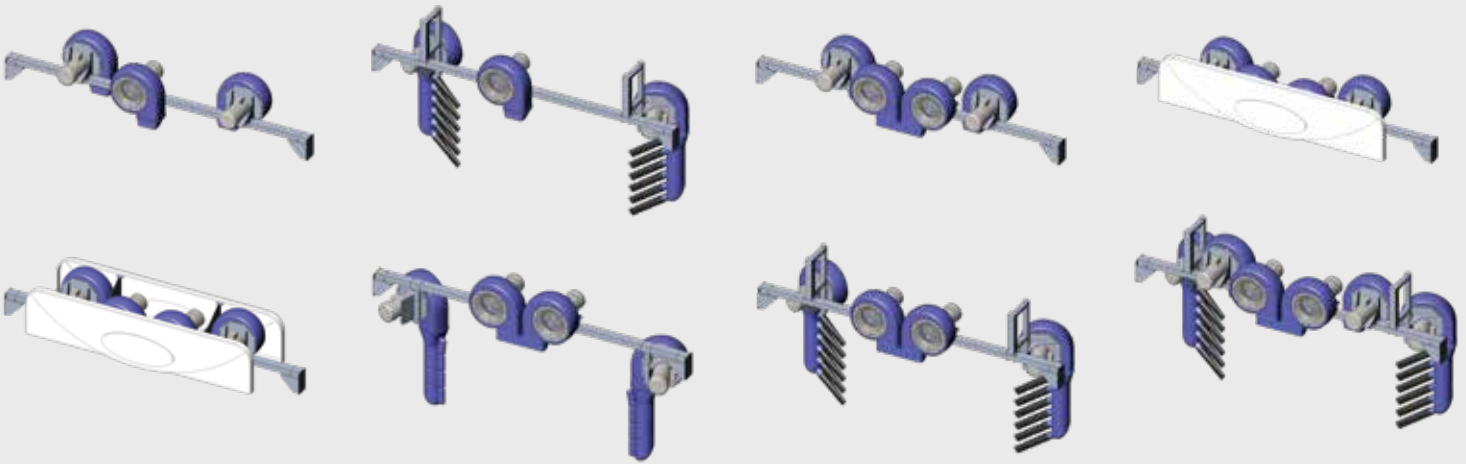



MOTORS
AVAILABLE
IN 5HP, 7.5HP,
10HP OR 15HP

Tunnel Dryer Applications

Common Tunnel Configurations

Additional and customizable configurations are available. Please contact us.

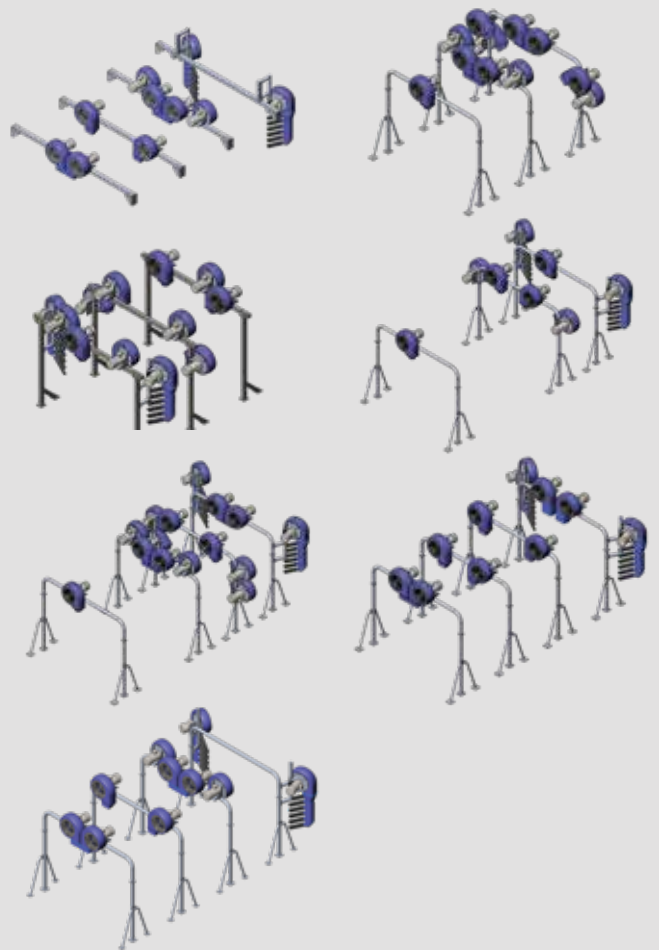



Producers



- HDPE producer housing colors available:



- Fiberglass cover with custom graphics available
- LED backlit cover with custom graphics available
- UL Listed VFD and standard starter panels available
- LED lighting available
- Custom applications available
- 5 HP available upon request

Producer Specifications

	7.5 HP Producer	10 HP Producer	15 HP Producer
208 V FLA	18.6 amps	24.9 amps	36.2 amps
230 V FLA	17.0 amps	22.5 amps	32.8 amps
460 V FLA	8.5 amps	11.2 amps	16.4 amps
SF amps	1.3	1.25/40	1.25/40
CFMs	3525	4200	4500
RPM	3525/60 Hz	3490/60 Hz	3500/60 Hz
Air Velocity	120 mph	135 mph	142 mph
TEFC Motors	3 Phase	3 Phase	3 Phase
Frame Size	215 Tc	215 Tc	215 Tc
Total Weight	220 lbs	230 lbs	230 lbs

Efficiency Level - (Minimum), 88.5% guaranteed efficiency, Nema NCM efficiency (Normal) 90.2%

Producer Nozzle Options

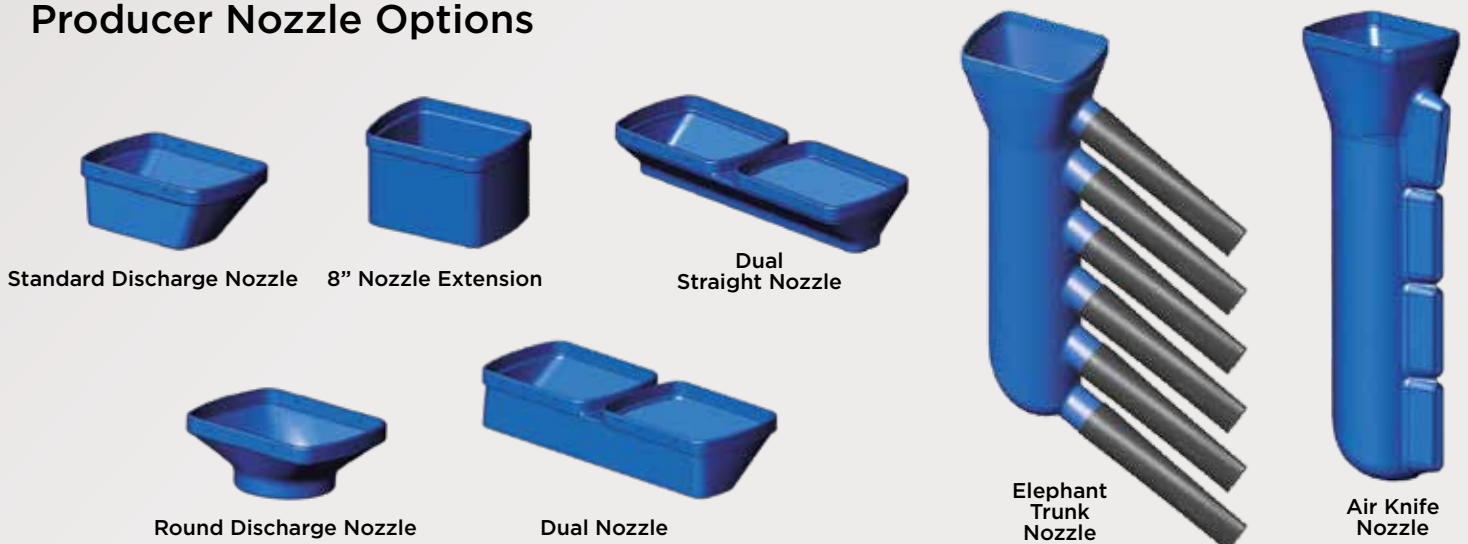

Oscillating Options

Motor Driven Oscillating Producers

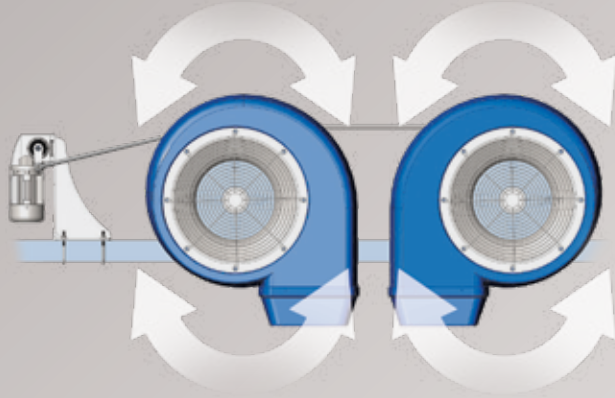

Dual Oscillator

0.25 HP 3ph Gear Motor • Approximately 30° Swing

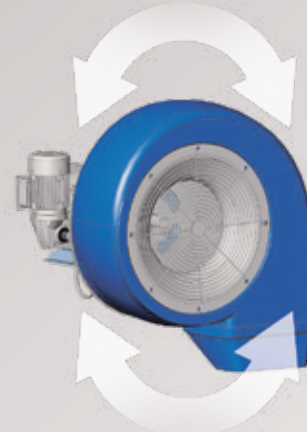

Single Oscillator

0.25 HP 3ph Gear Motor • Approximately 30° Swing

Air Driven Oscillating Nozzles



Single Oscillating Nozzle

2X Oscillating Blades
Approximately 30° Swing



Dual Oscillating Nozzle

4X Oscillating Blades
Approximately 30° Swing



Flip Nozzle

Air Outlet Direction Flips Forward to Reverse as Vehicle Passes

How Loud Are Our Producers?

Inside Door Closed

Distance From Bay	90 HP (6 - 15 HP)	60 HP (4 - 15 HP)	45 HP (3 - 15 HP)	10 HP (1 - 10 HP)
10 ft	102 dB	101 dB	100 dB	94 dB
20 ft	100 dB	99 dB	98 dB	92 dB
30 ft	98 dB	98 dB	98 dB	91 dB

Outside Door Open

Distance From Bay	90 HP (6 - 15 HP)	60 HP (4 - 15 HP)	45 HP (3 - 15 HP)	10 HP (1 - 10 HP)
10 ft	98 dB	95 dB	96 dB	90 dB
20 ft	92 dB	90 dB	89 dB	84 dB
30 ft	88 dB	86 dB	85 dB	79 dB
40 ft	84 dB	82 dB	82 dB	76 dB
50 ft	80 dB	80 dB	79 dB	74 dB

Decibel levels may drop 4 to 5 dB's or more with full cover surrounds or silencer cones. Readings may vary. Readings were conducted with Premier Plastic Housings.

Decibel Scale

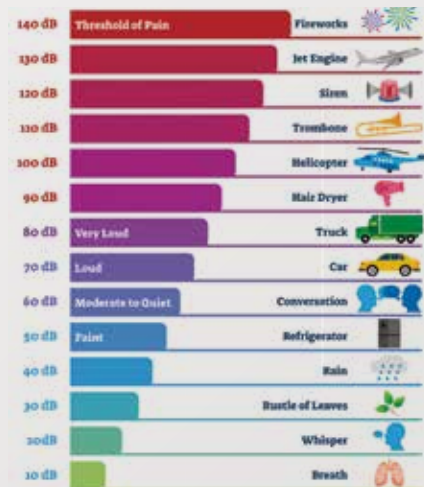



Introducing the New **Evolution Series**

Oscillating | Flip | Extending

Evolution Series Oscillating Nozzle

Oscillating Nozzle

- Swings left and right approximately 30 degrees
- Pneumatic or electric actuation
- Available in single or dual configurations

- HDPE producer housing colors available:

Blue	Black	Granite Gray	Red	Green	Yellow
- Fiberglass cover with custom graphics available
- LED backlit cover with custom graphics available
- UL Listed VFD and standard starter panels available
- LED lighting available
- Custom applications available
- 5 HP available upon request

Evolution Series Extending Nozzle

Extending Nozzle

- Cylinder extends nozzle up to 12" to follow the vehicle contour
- Retracted position offers the same clearance as our standard producers



Evolution Series Flip Nozzle

Flip Nozzle

- Swings approximately 15 degrees in both forward and backward directions
- Pneumatic or electric actuation
- Available in left, right, or dual configurations

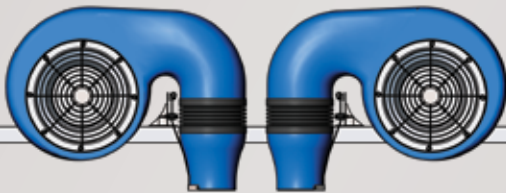
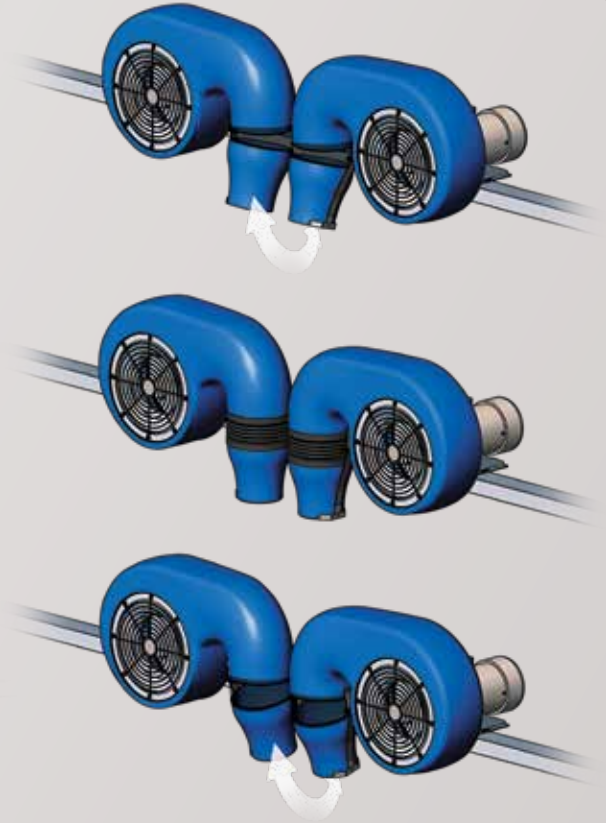

Fixed Nozzle Adapter

- May be used as a standalone nozzle, or as an adapter for air knives and e-trunks
- Allows an e-trunk or air knife to be adjusted 360 degrees



Producer Specifications

	7.5 HP Producer	10 HP Producer	15 HP Producer
208 V FLA	18.6 amps	24.9 amps	36.2 amps
230 V FLA	17.0 amps	22.5 amps	32.8 amps
460 V FLA	8.5 amps	11.2 amps	16.4 amps
SF amps	1.3	1.25/40	1.25/40
CFMs	3525	4200	4500
RPM	3525/60 Hz	3490/60 Hz	3500/60 Hz
Air Velocity	120 mph	135 mph	142 mph
TEFC Motors	3 Phase	3 Phase	3 Phase
Frame Size	215 Tc	215 Tc	215 Tc
Total Weight	220 lbs	230 lbs	230 lbs

Efficiency Level - (Minimum), 88.5% guaranteed efficiency, Nema NCM efficiency (Normal) 90.2%

Air Blanket

For Evolution Series



The Air Blanket attachment for Evolution Series provides a narrow, high-velocity blade of air up to 8+ feet wide. This narrow air path is angled, to better push water off vehicles.

PROVIDES
A NARROW,
HIGH-VELOCITY
BLADE OF AIR!



• HDPE producer housing colors available:





SAVE ENERGY
AND MONEY
WITH OUR
VFD PANELS!



VFD and Starter Panels

Features and Benefits

- Yaskawa VFDs (world leading VFD manufacturer)
- Arrives pre-programmed to your specific needs
- User-friendly with 24/7 technical support
- Energy rebates may be available in your area
- Energy savings from avoiding start up current
- Eco friendly
- No mechanical moving parts
- Unlimited performance options
- Extends parts and motor life
- Replaces existing starter panel
- Reduces noise levels
- Great return on investment
- Saves you money

Save Energy and Money

- At **58 hz**, owner saves **19%** on energy cost.*
- At **57 hz**, owner saves **24%** on energy cost.*
- At **55 hz**, owner saves **32%** on energy cost.*

* Data collected from 10 HP 208 volt during 60 second dryer time.



USE YOUR
PHONE'S
CAMERA TO
SCAN THE
CODE

Watch our video to learn more
about Premier VFD panels.





Arches and Overheads

These days, a car wash is about more than just a clean car. It's about providing your customers with a unique experience that makes a big impact. Our line of LED arches and overheads are sure to do just that. All of our signs are 120 volt, and are fully customizable with pucks, dots or spinners.

Our team of graphic designers are ready to create a standout arch that elevates our customer's brand. Creative designs and fast turnaround times, paired with the quality you've come to expect from Premier, turns a cruise through a wash into an illuminated adventure all can enjoy. Choose from our lineup of standard arches, or contact us for a one-of-a-kind custom design.



ADD PUCKS, SPINNERS OR DOTS FOR ADDED IMPACT!

Signage



ALL SIGNS ARE
HAND CRAFTED AT
OUR WISCONSIN
FACILITY

Light Effects
Arch with
Shield Top
Shown

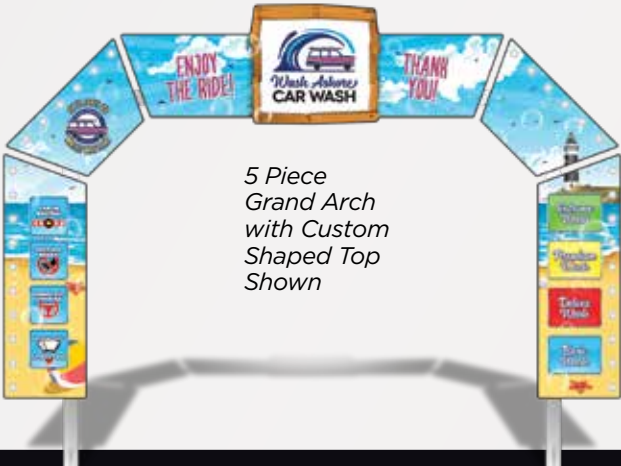
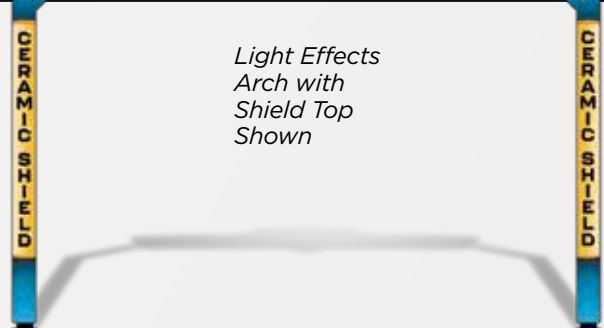

5 Piece
Grand Arch
with Custom
Shaped Top
Shown

All of our signs are hand
crafted with pride at our central
Wisconsin facility. We offer
a full line of standard arch
shapes, or we can custom build
an arch to suit your needs.

CHOOSE A
STANDARD ARCH,
OR MODIFY IT TO
SUIT YOUR NEEDS



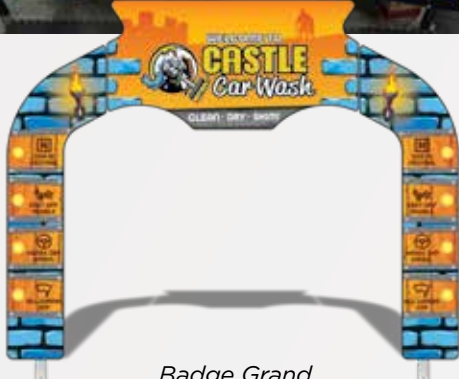

Badge Grand Arch with 4" Pucks and Dots Shown



Add Light Effect Options to Your Arch or Sign



4" LED Puck Lights

- Can be set to on, strobe or halo effect
- Available in green, blue, yellow, red and white



2" LED Spinners

- Available in green, blue, yellow, red, white and pink



1" Dot Light

- Available in white

Flashers and Sequence Flashers



Premier Arch





Badge Arch

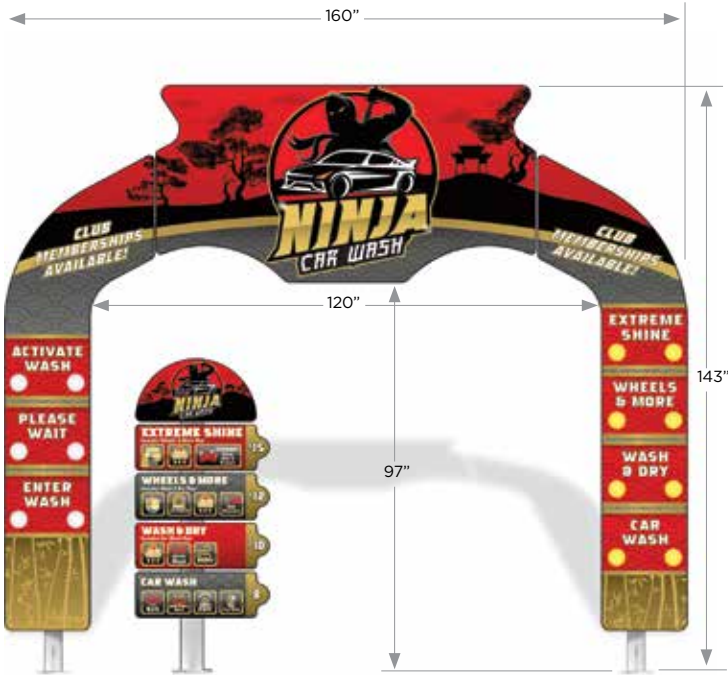

Badge Grand Arch Shown with Matching Sectional Menu

Shield Arch



3 Piece Arch



5 Piece Arch

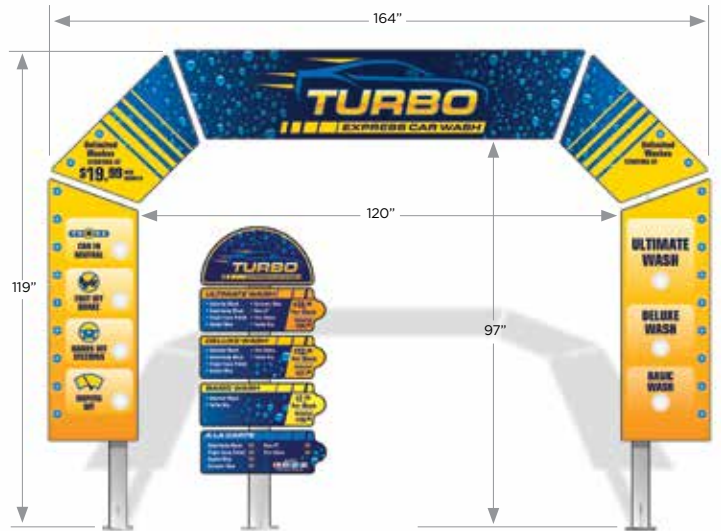

5 Piece Grand Arch Shown with Matching Sectional Menu

Rain Drop Arch

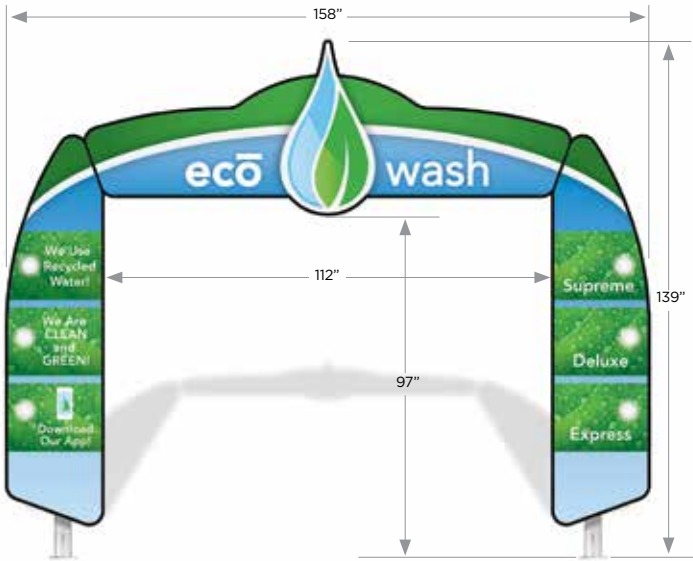

Light Effects Arch

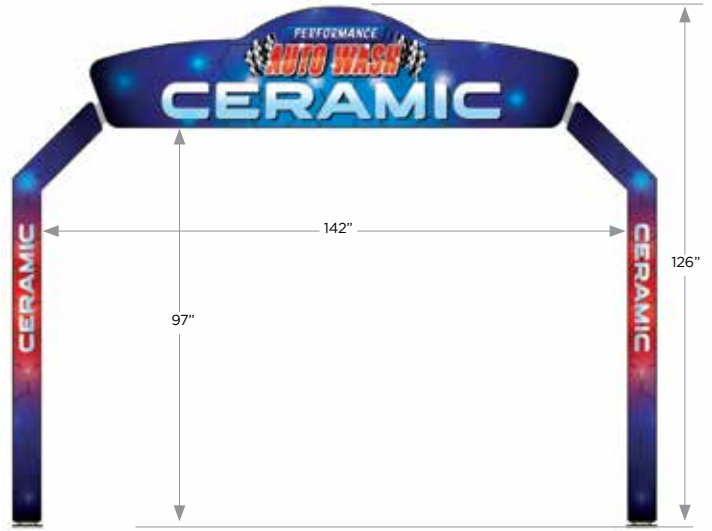

Custom Shaped Arches





Menu and Menu Boards



OUR DURABLE SECTIONAL MENU HOUSINGS ARE AVAILABLE IN 6 COLORS!

Sectional Menus

- 3-6 Sections Available
- 33" Wide x 96" High
- HDPE Color Options Include Red, Blue, Black, Granite Gray, Green and Yellow
- Custom Powder Coated Pedestal Available
- 120 Volt
- Aluminum Construction



Menu Boards

- Many Sizes Available
- Metal Color Options Include Red, Blue, Yellow, White and Black
- 120 Volt
- Aluminum Construction



Custom Menu Boards

- Create a Menu That Matches Your Image and Logo
- Metal Color Options Include Red, Blue, Yellow, White and Black
- 120 Volt
- Aluminum Construction



Instructionals & Sectionals

- Available in Single Post or Wall Mount
- 120 volt
- Dual Pivot Stainless Steel Arms for Adjustability
- Metal Color Options Include Red, Blue, Yellow, White and Black



Pay Station Canopies



Double Leg Canopy

- Shown With Laser Cut “Pay Here” and Lit Roto-Molded “Clearance” Signs
- Roof Live Load: 40 psf
- RFID Reader Mount Available
- Single Leg Canopy Available (Flat Top Only)
- Basic Wind Speed: 130 mph



Arch Canopy Top

- Shown With LED Lit “Pay Here” and Lit Roto-Molded “Clearance” Signs
- Roof Live Load: 40 psf
- RFID Reader Mount Available
- Basic Wind Speed: 150 mph

Features

- Double coated powder coating process with a zinc primer base and colored second coat
- Powder coated extruded aluminum top without ridges to eliminate debris buildup and nesting
- Laser-cut holes in post for neat and efficient electrical installation
- RFID reader mount available
- Footing covers for a clean look

Lighting Options

- (1) 4’ 5K LED included
- RGB upgrade available
- Jumper cables and off-site controls available with the Premier Hub

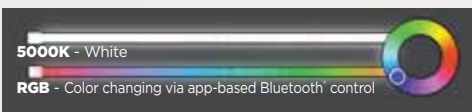

Included

- Laser-cut “Pay Here” sign
- (1) 4’ 5K LED

Color Options

- Blue, black, red, green or yellow
- Custom colors available by request

Optional Upgrades

- Additional LED lighting
- J-anchor template kit
- Lit “Pay Here” sign
- Lit “Clearance” sign
- Customizable artwork to meet your customer’s expectations and brand



LED Sign Lit Options



Unlit Sign Options





Wall Mount & Pedestal Sectionals

- 2 - 8 sections available
- All signs are 120 Volt
- Dual pivot stainless steel arms for adjustability
- LED puck color options: red, white, blue, yellow and green
- Powder coat color options: red, blue, black, yellow and white
- Stainless steel construction
- HDPE housing colors:

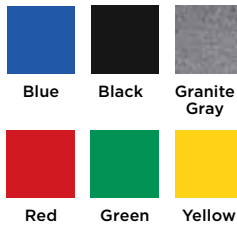

Roto-Molded Signs

- All signs are 120 Volt
- Stainless steel construction
- HDPE housing colors:



Clearance



ALL SHAPES AVAILABLE IN WALL MOUNT OR PEDESTAL

Tunnel/Wall Signs

- HDPE and aluminum housings available
- LED spinner light color options: red, blue, green, yellow, pink and white
- Stainless steel construction
- HDPE housing colors:

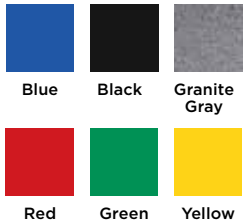

- 24" round or square



OUR DURABLE HDPE HOUSINGS ARE AVAILABLE IN 6 COLORS!

12" X 47.5" SHOWN WITH 2" GREEN SPINNERS

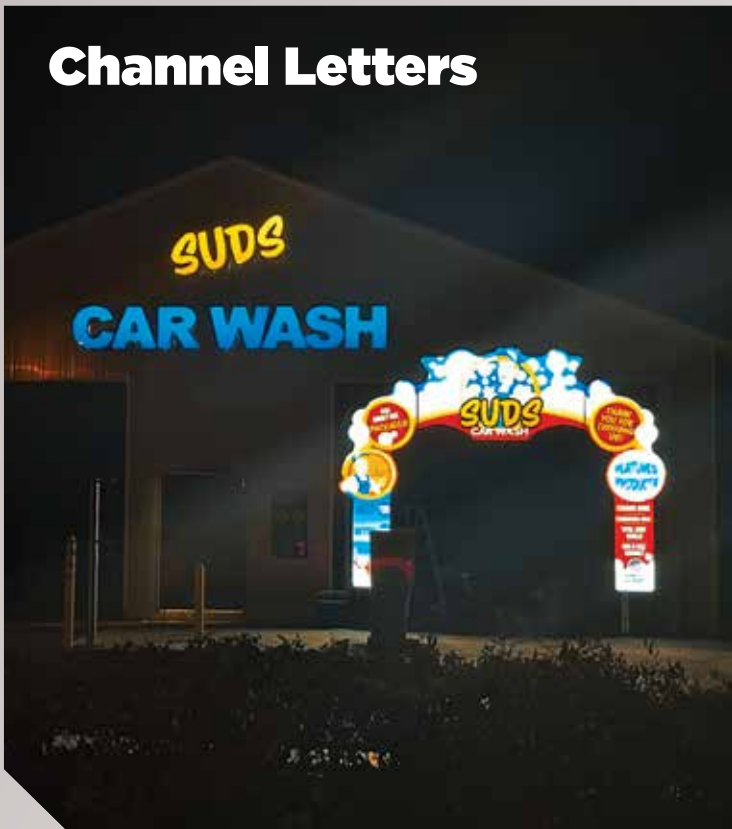

- 24", 30" and 36" letters available
- Many options and colors available. Please call for more information.

Clearance Signs & Structures

Straight Top Clearance Structures

- Built in-house
- Many powder coat colors available



MANY POWDER COAT COLORS ARE AVAILABLE!

CLEARANCE 7'6"



Curved Top Clearance Structures

- Built in-house
- Many powder coat colors available
- Shown with custom ACM printed sign

Roto-Molded Clearance Signs

- Available both Lit and Unlit
- Custom designs and colors available
- HDPE housing colors:



Blue Black Granite Gray Red Green Yellow



Dual Leg Clearance Structures

- Built in-house
- Many powder coat colors available
- Can be customized to any size needed

Custom Shaped Pedestals & Wall Mounts

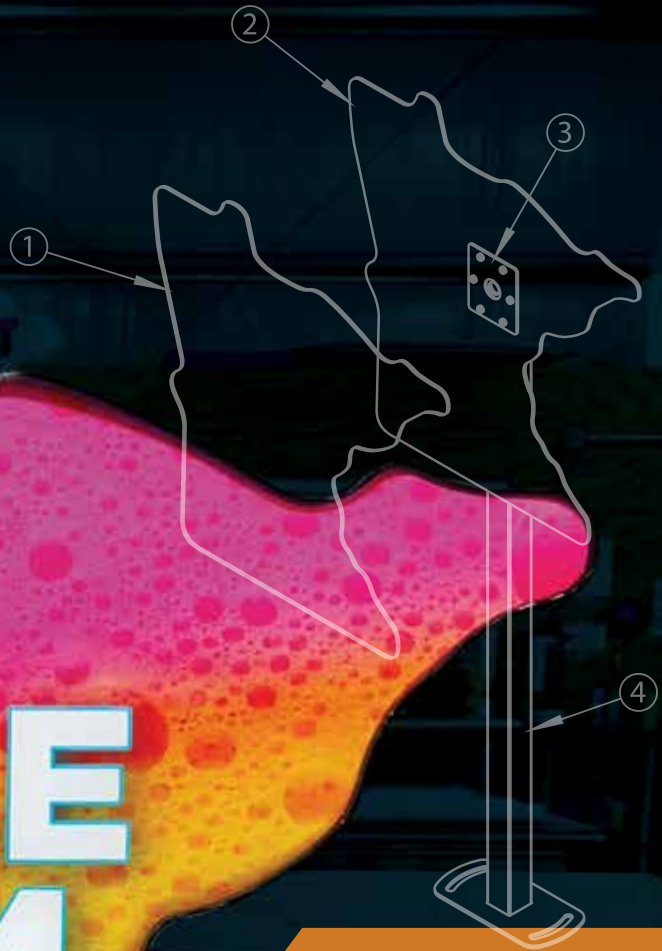

Because we build everything in-house, our experienced team of designers, engineers and craftsmen have the capability to build just about any shape of sign your customers might need. Let us know how we can help.



ACM Printed Signs

(Aluminum Composite Material)

- Laminated with a UV resistant material for added durability
- Can be used in-bay or outside
- Many sizes available
- Can be wall-mounted or mounted to a post



ACM Printed In-Bay Signage

(Aluminum Composite Material)

- Laminated with a UV resistant material for added durability
- Can be used to add color to and promote products in self serve bays
- Many sizes available
- Can be wall-mounted





Stainless Steel Canopy Vacs

2 OR 3 MOTOR OPTIONS (220v motor upgrade available):

- 2 - 120v motors with 2" hose: FLA = 25 amps, 223 CFM, 910 AirWatts
- 3 - 120v motors with 2" hose: FLA = 35 amps, 315 CFM, 1212 AirWatts
- 220v motors:
 - 2 motors = 15 amps, 223 CFM, 620 AirWatts
 - 3 motors = 25 amps, 315 CFM, 931 AirWatts

Vacuum Specs

- 4-bag filter system
- 2 accessible back doors for easy clean out
- Tough upholstery tool with swivel cuff
- Added money box lock bar for security
- **Express 1** includes push button or toggle switch options
- **Express 2** offers multiple timer, coin, bill and credit card options
- Powder coating available
- Other options include light poles with LED lights, post covers and mat holders
- Dome colors:
- Hose colors:
- Canopy colors:
- Custom canopy colors available upon request





Premier Express-1 Vac

- Single vac station with boom
- LED upgrades available
- Push button or toggle switch start



Premier Single Express-2 Vac With Meter Box

- Single vac station with dual boom
- Canopy add-on for dual vac station
- Pedestal mounted nozzle holder
- LED upgrades available



Premier Single Express-2 Vac With Meter Box

- Single vac station with dual boom
- Canopy add-on for dual vac station
- Garbage can add-on
- LED upgrades available



Premier Dual Express-2 Vac With Individual Meter Boxes

- Dual vac station with dual boom
- Canopy add-on for dual vac station
- LED upgrades available



Silver Bullet

- Stainless steel cabinet
- Crevice tool
- Easy clean out door
- Single 120v motor
- Wire with another vacuum or toggle switch option
- Plastic domes available in:

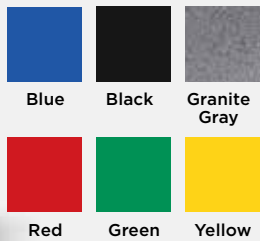

Premier Vacs are equipped with newly designed high efficiency vacuum motors gaining 85% more performance with two motors, outperforming the competition's three motor and central vac systems.

Want even more performance? A third motor will not disappoint. The Premier Vac features a newly designed silencing system that makes it the quietest vacuum on the market today.

- Options include light poles with LED lights, post covers and mat holders
- Available hose colors: red, blue, yellow, black and grey
- Available standard and lit dome colors:





Stainless Steel Vacs

2 OR 3 MOTOR OPTIONS (220v motor upgrade available):

- 2 - 120v motors with 2" hose: FLA = 25 amps, 223 CFM, 910 AirWatts
- 3 - 120v motors with 2" hose: FLA = 35 amps, 315 CFM, 1212 AirWatts
- 220v motors:
 - 2 motors = 15 amps, 223 CFM, 620 AirWatts
 - 3 motors = 25 amps, 315 CFM, 931 AirWatts



Premier Express Vac

- 2 or 3 motor options (3 motor 35 FLA, 2 motor 25 FLA)
- 4-bag filter system
- 2 accessible back doors for easy clean out
- Tough upholstery tool with swivel cuff
- Added money box lock bar for security
- **Express 1** includes push button or toggle switch options
- **Express 2** offers multiple timer, coin, bill and credit card options
- **Express 3** features air and vacuum
(Not available with 3rd motor)



Premier Aroma Vac

- 2 or 3 120v motor options (3 motor 35 FLA, 2 motor 25 FLA)
- Dispenses 3 fragrances of your choice
- 4-bag filter system
- 2 accessible back doors for easy clean out
- Tough upholstery tool with swivel cuff
- Bright LED display timer with adjustable price per function
- Optional coin, bill or credit card acceptors



Premier Executive Vac

- 2 or 3 120v motor options (3 motor 35 FLA, 2 motor 25 FLA)
- 4-bag filter system
- Dispenses shampoo and 3 fragrances of your choice
- 2 accessible back doors for easy clean out
- Tough upholstery tool with swivel cuff
- Bright LED display timer with adjustable price per function
- Can be set up to accept coins, bills and/or credit cards



Premier Magic Vac

- 2 or 3 120v motor options (3 motor 35 FLA, 2 motor 25 FLA)
- Dispenses shampoo and spot remover
- 4-bag filter system
- 2 accessible back doors for easy clean out
- Tough upholstery tool with swivel cuff
- Bright LED display timer with adjustable price per function
- Multiple coin, bill and credit card acceptor options



Palm Dryers

- **110V AC**
(3 Motor) 50 amp service
(2 Motor) 30 amp service
- **240V AC**
(3 Motor) 25 amp service
(2 Motor) 20 amp service
- Relay: 110v, 24v or wired direct
- Available in attic mount, half wall pedestal mount or wall mount
- Available hose colors: red, blue, yellow, black and gray
- Available dome colors:

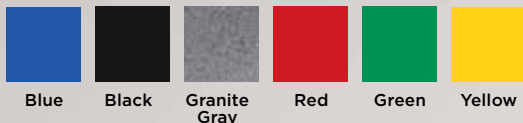

Palm Dryers



MANY HOSE AND DOME COLOR OPTIONS AVAILABLE



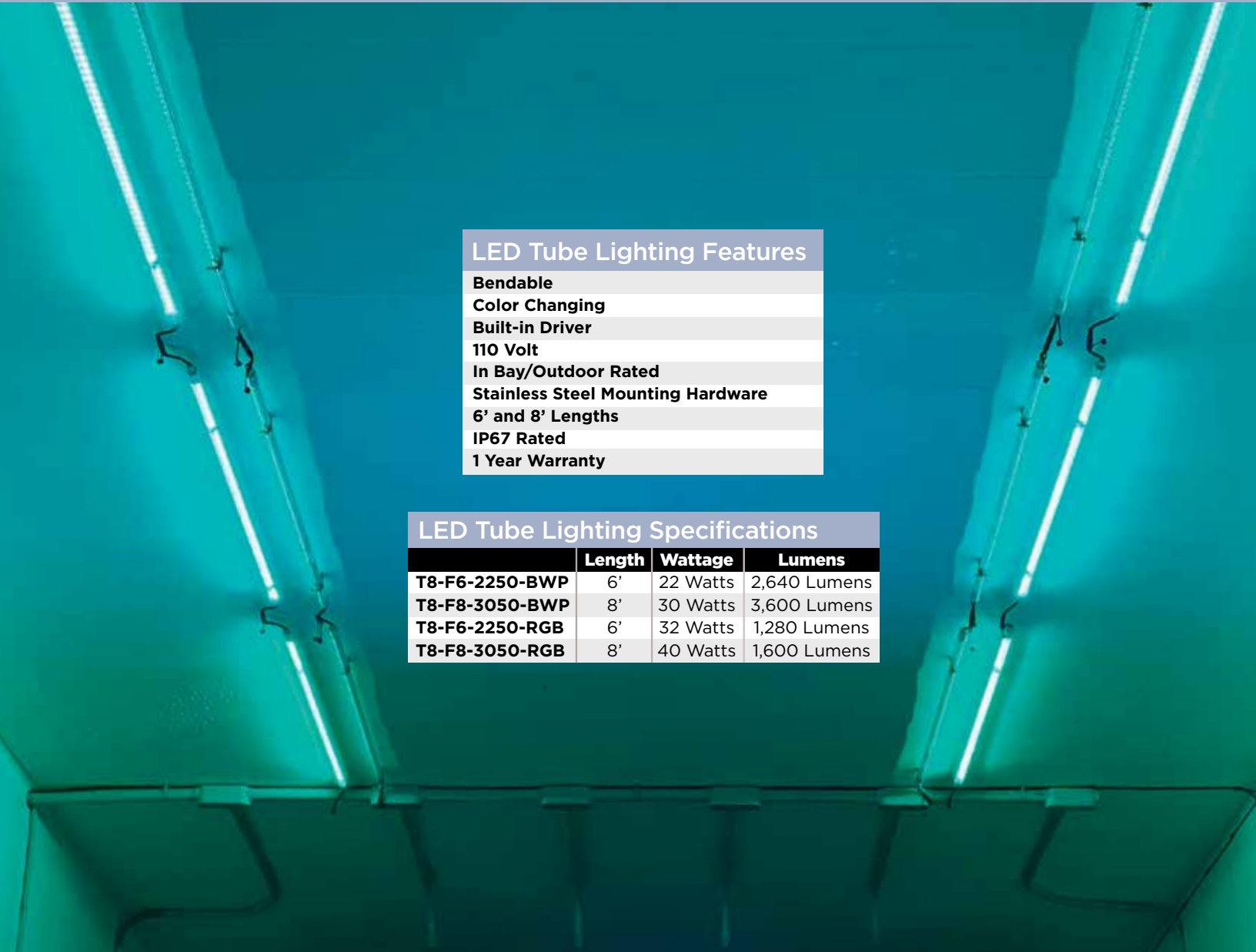

LED Tube Lighting Features

- Bendable**
- Color Changing**
- Built-in Driver**
- 110 Volt**
- In Bay/Outdoor Rated**
- Stainless Steel Mounting Hardware**
- 6' and 8' Lengths**
- IP67 Rated**
- 1 Year Warranty**

LED Tube Lighting Specifications

	Length	Wattage	Lumens
T8-F6-2250-BWP	6'	22 Watts	2,640 Lumens
T8-F8-3050-BWP	8'	30 Watts	3,600 Lumens
T8-F6-2250-RGB	6'	32 Watts	1,280 Lumens
T8-F8-3050-RGB	8'	40 Watts	1,600 Lumens



The Premier LED App allows complete access to lighting controls from your phone, tablet or computer.

Control multiple locations and make changes while off-site with ease using the Premier Hub,

Premier Tube Lighting is bendable and built to perform in the harshest conditions. Made to be in bay as well as outdoors, these lights create an eye-popping focal point for your facilities and outdoor canopy systems.

LED Lighting



COLOR CHANGING
POWERED BY THE
PREMIER APP!

ROOM
MANAGEMENT
CONTROLLED BY
THE APP

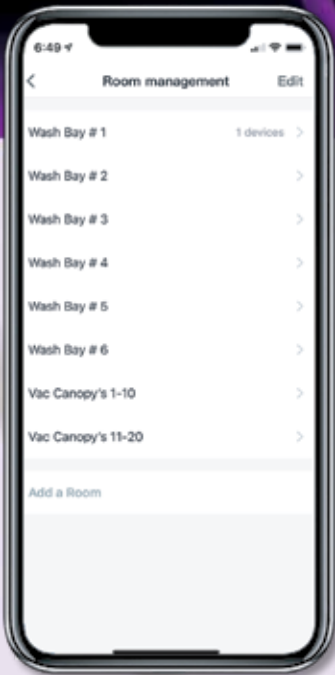



VISIT US ONLINE



premier

Your Manufacturing Partner

2210 Heldt Street
Merrill, WI 54452
866.539.3100

sales@precisionlasercutting.com
premiercompaniesusa.com

